

Features:

- Acrylic diffused LED back lighting
- CRI 90+ R9>50
- 2700K-6500K color temperature adjustment
- 10%-100% light dimmer
- Brightness and color temperature memory settings
- Heated mirror defogger
- Touch on/off
- Safety film backing
- Copper free
- IP44 rated for safe use in bathrooms
- ETL certified for North American use
- 110V plug in installation, can be hardwired
- Can be controlled with a light switch
- Lamp life : 50,000 hours

Size (WxHxD):

35 3/8" x 35 3/8" x 1 1/8"
 (900mm x 900mm x 30mm)

Model #	Description	Color Temperature	Lumens	Watts	Volts	Weight (lb)
IA1036	Atlas 36" LED Mirror	2700K - 6500K	2550	18W	110V	20.5

Warranty: 5 Years - refer to www.icobath.com for full warranty coverage details.

Included Hardware: Screws, mounting brackets are included.

Care & Maintenance: A periodic wash using warm water and a soft cloth will retain the quality of your LED mirror for many years to come. ON NO ACCOUNT should any household bleaches, detergents, abrasive polishes, steel wool or other cleaning agents be used on this item.

Diagram and measurements:

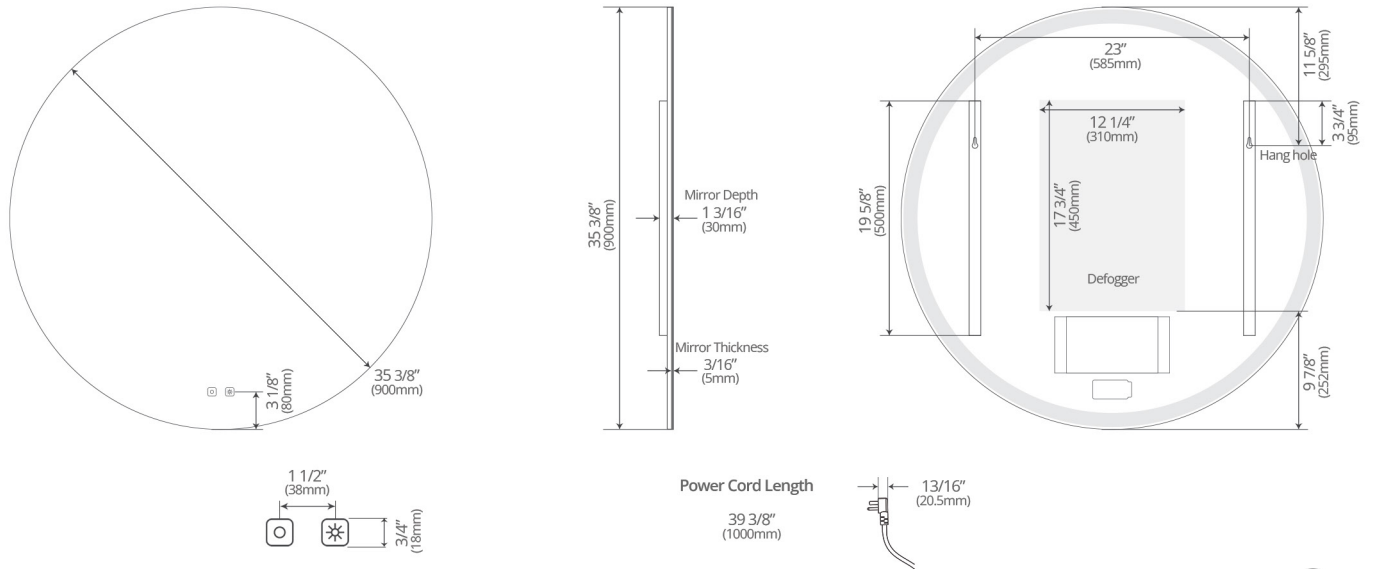

Touch button details:

