



**Warmup**<sup>®</sup>

## Owner's Guide

***TH115-AF-GA / TH115-AF-GB***

---

**Programmable thermostat**

## Table of contents

### Overview

Before you start.....	2
About your thermostat.....	3
Controls.....	4
Display.....	5

### Installation

Installing the thermostat.....	6
Wiring diagrams.....	7
Connecting the floor sensor / remote control.....	8
Setting the configuration switches.....	9

### Setup

Time and day.....	10
Daylight Saving Time.....	11
Floor temperature limits.....	12
Preset temperatures.....	13

Default schedule.....	14
Modifying the schedule.....	15

### Operation

Running the schedule (Automatic mode).....	16
Temporary override of schedule.....	16
Permanent override (Manual mode).....	17
Before going on vacation (Vacation mode).....	17
Ground fault protection (GFCI).....	18

### Appendices

Error messages.....	20
Technical specifications.....	21
Customer assistance.....	22
Warranty.....	23

## Before you start

### Read the entire document

#### CAUTION:

- Installation must be carried out by a certified electrician and must comply with national and local electrical codes.
- Use this thermostat for resistive loads only.
- Do NOT install the thermostat in an area where it can be exposed to water or rain.
- To prevent severe shock or electrocution, always turn the power Off at the service panel before working with wiring.
- Install the thermostat onto an electrical box.
- Use special CO/ALR solderless connectors if you connect the thermostat to aluminum wires.
- Keep the thermostat's top and bottom air vents (openings) clean and unobstructed at all times.

## About your thermostat

The TH115 programmable thermostat has three temperature control modes:

- |                 |  |
|-----------------|--|
| <b>A mode:</b>  | ▶ controls the ambient air temperature   |
| <b>F mode:</b>  | ▶ controls the floor temperature using an external temperature sensor  |
| <b>AF mode:</b> | ▶ controls the ambient air temperature<br>▶ maintains the floor temperature within desired limits using an external temperature sensor |

See page 9 on how to change the temperature control mode setting.

### Supplied Parts

- One (1) thermostat
- Two (2) mounting screws
- Four (4) solderless connectors for copper wires
- One (1) floor sensor
- One (1) flat-tip screwdriver

## Controls

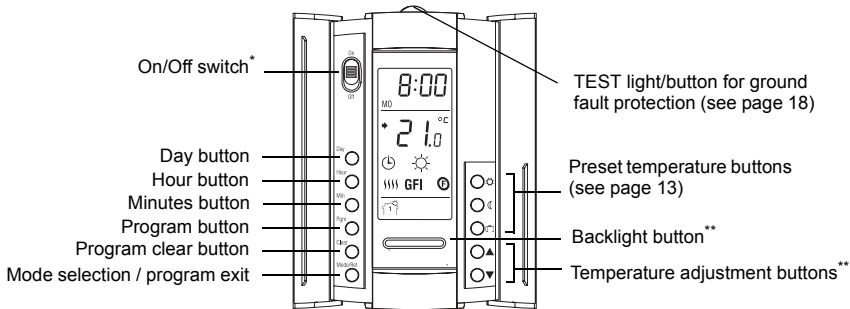

\* Place at Off to cut power to the heater (e.g., in the summer). This will not affect the time and temperature settings.

\*\* When the backlight button or either of the ▲▼ buttons is pressed, the display illuminates for 12 seconds.

## Display

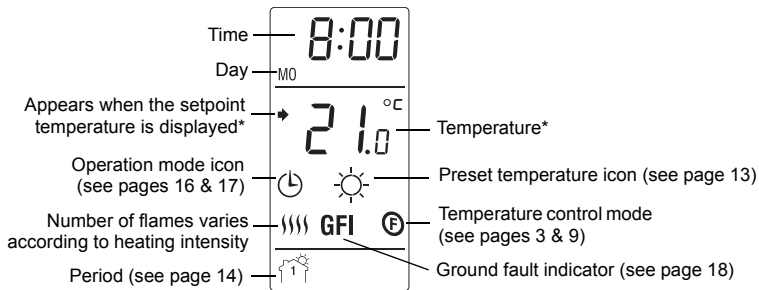

\* The thermostat normally displays the actual (measured) temperature. To view the setpoint temperature, briefly press either of the ▲▼ buttons. The setpoint will appear for 5 seconds. To change the setpoint temperature, press one of the ▲▼ buttons until the desired temperature is displayed. To scroll faster, press and hold the button.

## Installing the thermostat

- 1 Turn the heating system off at the main electrical panel.
- 2 Loosen the bottom screw and remove the thermostat faceplate from its wallplate. (The screw cannot be completely removed.)
- 3 Connect the thermostat to the load and to the power supply (see page 7).
- 4 Connect the floor sensor (see page 8).
- 5 If you wish to connect a remote control device, see page 8.
- 6 Install the wallplate to the electrical box using the provided screws.
- 7 Set the configuration switches on the back of the faceplate (see page 9).
- 8 Install the faceplate back on the wall plate and tighten the screw.
- 9 Apply power to the heating system.
- 10 Test the ground fault protection (see page 19).

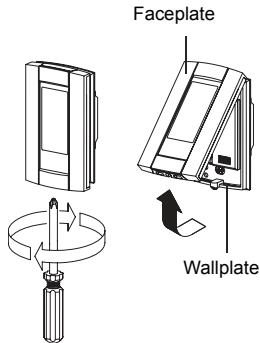

## Wiring diagram

**NOTE:** Connect the wires using the provided solderless connectors for copper wires.

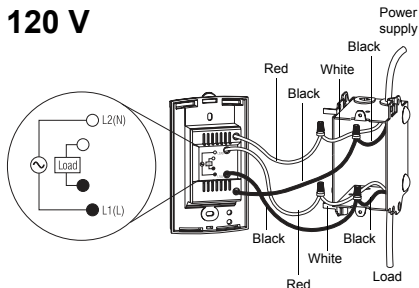
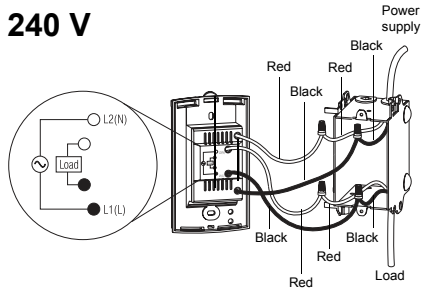



## Connecting the floor sensor / remote control

ENGLISH

- 1 Insert the floor sensor cable through one of the two openings on the wallplate and connect the sensor wires to terminals 1 and 2 (no polarity).

  - The sensor cable must not come in contact with the electrical wires and must be routed outside the electrical box and follow the wall down to the floor.
  - Position the sensor cable such that it does not come in contact with the floor heating wires. The sensor must be centered between two floor heating wires for best temperature control.
  - Do NOT staple the sensor head (the plastic end) to the floor. Doing so might damage the sensor. Any damage might not be noticeable during testing but can become apparent several days later.
- 2 If you wish to connect a remote control device (see page 17), insert the wires (use 18- to 22-gauge flexible wires) through one of the two openings on the wallplate and connect them to terminals 2 and 3 (no polarity).

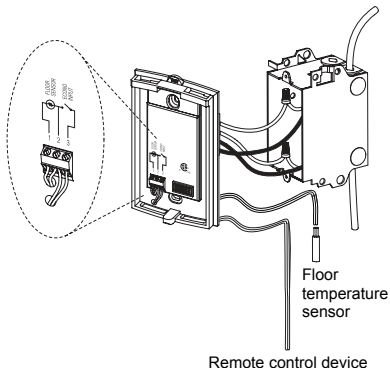

## Set the configuration switches

Configuration switches are on the back of the faceplate.

#	Configurations	Up	Down
1	Display format	°F / 12 h	°C / 24 h
2	Early Start <sup>1</sup>	Enable	Disable
3	Temperature control mode <sup>2</sup>	F	AF

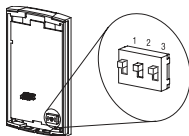

1. Early Start is used in Automatic mode only. When Early Start is enabled (on), the thermostat determines when to start heating so the Comfort temperature is attained at the beginning of periods 1 and 3. When Early Start is disabled (off), heating starts only at the beginning of periods 1 and 3; thus there is a delay before the Comfort temperature is reached.
2. See page 3. To select the F Mode, place the switch in the F position. To select the AF Mode, place the switch in the AF position and ensure that the temperature sensor is connected to the thermostat. To select the A Mode, place the switch in the AF position and ensure that the remote temperature sensor is **NOT** connected to the thermostat.

## Time and day

To set the clock and the day:

- 1 Press the **Hour** button to set the hour.
- 2 Press the **Min** button to set the minutes.
- 3 Press the **Day** button to set the day.
- 4 Press the **Mode/Ret** button to return the thermostat to normal display.

**NOTE:** *The thermostat will automatically return to normal display if no button is pressed for 60 seconds.*

## Daylight Saving Time

When the Daylight Saving Time function is enabled (On), the thermostat automatically switches to Daylight Saving Time on the second Sunday of March and to normal time on the first Sunday of November.

**NOTE:** *The Daylight Saving Time function is disabled (default setting) when the clock loses its setting.*

To set the Daylight Saving Time function and to set the date:

- 1 Press the **Day** button (3 seconds) until **DLS** appears on the screen.
- 2 Press either of the ▲▼ buttons to toggle between **On** (enabled) and **Off** (disabled).
- 3 Press the **Day** button briefly. The year setting is displayed.
- 4 Press either of the ▲▼ buttons to set the current year.
- 5 Press the **Day** button briefly. The month setting is displayed.
- 6 Press either of the ▲▼ buttons to set the current month.
- 7 Press the **Day** button briefly. The date setting is displayed.
- 8 Press either of the ▲▼ buttons to set the current date.
- 9 Press the **Mode/Ret** button to return the thermostat to normal display.

**NOTE:** *The thermostat will automatically return to normal display if no button is pressed for 60 seconds.*

## Floor temperature limits (AF mode only)

**WARNING:** To avoid damaging your floor, follow your floor supplier's recommendations regarding floor temperature limits.

The minimum and maximum floor temperature limits are 5.0°C (41°F) and 28.0°C (82°F) by default. To modify these limits, proceed as follows:

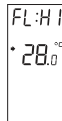
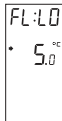

- 1 Switch the thermostat to Off.
- 2 Press and hold the ☀ button.
- 3 Switch the thermostat back to On.
- 4 Release the ☀ button when the minimum temperature limit (FL:LO) appears.
- 5 Set the minimum temperature limit using the ▲▼ buttons.
- 6 Press the ☀ button to display the maximum temperature limit (FL:HI).
- 7 Set the maximum temperature limit using the ▲▼ buttons.
- 8 Press **Mode/Ret** to return the thermostat to normal display.





**NOTE:** The thermostat will automatically return to normal display if no button is pressed for 60 seconds.

## Preset temperatures



The thermostat has 3 preset temperatures. Their default settings are shown in the following table.

Preset temperature	Intended use	Icon	A/AF modes	F mode
Comfort	When at home		21.0°C (70°F)	28.0°C (82°F)
Economy	When asleep or away from home		17.0°C (63°F)	20.0°C (68°F)
Vacation	During prolonged absence		10.0°C (50°F)	10.0°C (50°F)

### To use a preset temperature:

Briefly press the appropriate preset temperature button (,  or ). The preset temperature will become the current setpoint and its icon will appear on the screen.

### To modify a preset temperature:





- 1 Press one of the ▲▼ buttons to display the desired temperature.
- 2 Press and hold the appropriate preset temperature button (,  or ) until its icon is displayed.

## Default schedule

The schedule consists of 4 periods per day, which represents a typical work day. The Comfort (☀) preset temperature is automatically used in Periods 1 and 3 and the Economy (☾) preset temperature in Periods 2 and 4. You can program the thermostat to skip (cancel) the periods that do not apply to your situation. For example, you can skip periods 2 and 3 for the weekend.

**NOTE:** If you wish to use only 2 periods, use the following combinations: "1 and 4" or "2 and 3". Early Start (see page 9) will not work with any other combinations.

You can have a different program every day; i.e., each period can start at a different time every day. The thermostat has been programmed with the following schedule.

Period	Description	Setting	MO	TU	WE	TH	FR	SA	SU
	Wake	Comfort ☀	6:00	6:00	6:00	6:00	6:00	6:00	6:00
	Leave	Economy ☾	8:30	8:30	8:30	8:30	8:30	--:--	--:--
	Return	Comfort ☀	17:00	17:00	17:00	17:00	17:00	--:--	--:--
	Sleep	Economy ☾	23:00	23:00	23:00	23:00	23:00	23:00	23:00

## Modifying the schedule

- 1 Press **Pgm**. Period 1 for Monday is displayed.
- 2 To program another period, press **Pgm** to display that period.
- 3 To program another day, press **Day** to display that day (hold for 3 seconds to select the entire week).
- 4 Press **Hour** and **Min** to set the period start time, or press **Clear** to skip (cancel) the period (--:-- will be displayed).
- 5 Repeat steps 2 to 4 to program another period.
- 6 Press **Mode/Ret** to return the thermostat to normal display.





**NOTE:** *The thermostat will automatically return to normal display if no button is pressed for 60 seconds.*







## Running the schedule (Automatic mode)

In Automatic mode, the thermostat follows the programmed schedule (see page 14). To place the thermostat in this mode, press **Mode/Ret** until  is displayed.

## Temporary override of schedule



If you modify the setpoint temperature (by pressing the ,  or  button) when the thermostat is in Automatic mode, the new temperature will be used until the beginning of the next period.  flashes during the temporary override. You can cancel the temporary override by pressing **Mode/Ret**.

## Permanent override of schedule (Manual mode)

To place the thermostat in Manual mode, press **Mode/Ret** to display  on the screen. In this mode, the thermostat does not follow the programmed schedule. Press the ,  or  button to set the temperature.

## When you go on vacation (Vacation mode)

In this mode, the thermostat uses the vacation preset temperature (see page 13). There are two ways to place the thermostat in Vacation mode:

- ▶ Press the  button on the thermostat. When the Vacation mode is activated this way, the  icon appears on the screen without flashing.
- ▶ From any remote control device equipped with a dry contact. When the contact closes, the thermostat is placed in Vacation mode and the  icon flashes on the screen. All buttons on the thermostat are locked. When the contact opens, the thermostat returns to the previous mode.

**NOTE:** *When the Vacation mode is activated from a remote control device, it can only be deactivated using the device.*

## Ground fault protection (GFCI)

This ground fault protection thermostat is different from conventional thermostats. In the event of a ground fault, the ground fault protection mechanism on the thermostat will trip and quickly stop the flow of electricity to prevent serious injury.

### Definition of a ground fault

Instead of following its normal safe path, electricity passes through a person's body to reach the ground. For example, a defective floor heating mat can cause a ground fault.

A ground fault protection thermostat **does not protect** against circuit overloads, short circuits, or electrical shocks. For example, you can still receive an electrical shock if you touch bare wires while standing on a non-conducting surface such as a wood floor.

### Ground fault protection reset

When the ground fault protection mechanism trips, the TEST light is On (red). To reset the ground fault protection, switch the thermostat to Off and back to On. The TEST light will turn off.

## Testing the ground fault protection

To ensure the ground fault protection is always in working order, test it once the thermostat is installed and on a monthly basis thereafter.

- 1 Increase the setpoint temperature above the measured temperature in order to activate the heating system.
- 2 Press the TEST button.
  - If the TEST light does NOT turn on, **the test has failed**. Cut power to the heating system at the main electrical panel, have an electrician verify the installation and, if necessary, replace the thermostat.
  - If the TEST light turns on, continue the test.
- 3 Switch the thermostat to Off then back to On.
  - If the TEST light turns off, **the test has passed**. Set the thermostat back to the desired temperature. The test is now completed.
  - If the TEST light remains on, **the test has failed**. Continue with the rest of the procedure.
- 4 Switch the circuit breaker (at the service panel) of the heating system to off then back to on.
- 5 Repeat the test. If the test fails again, cut power to the heating system at the main electrical panel, have an electrician verify the installation and, if necessary, replace the thermostat.

TEST button/light

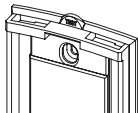

## Error Messages

- L0** The measured temperature is below the display range. Heating is activated.
- H1** The measured temperature is above the display range. Heating is deactivated.
- Er** Verify the thermostat connection and sensor connection.

## Technical Specifications

Model	Supply	Max. load (resistive only)		Ground Fault Protection (GFCI)	Wiring
		Current	Power		
TH115-AF-GA	120 VAC, 60 Hz	15 A	1800 W	5 mA	4 wires, double pole
	240 VAC, 60 Hz		3600 W		
TH115-AF-GB	120 VAC, 60 Hz		1800 W	15 mA	
	240 VAC, 60 Hz		3600 W		

**Display range:** 0°C to 70.0°C (32°F to 158°F)

**Ambient setpoint range (A/AF modes):** 5.0°C to 30.0°C (40°F - 86°F)

**Floor setpoint range (F mode):** 5.0°C to 40.0°C (40°F - 104°F)

**Floor limit range (AF mode):** 5.0°C to 40.0°C (40°F - 104°F)

**Resolution:** 0.5°C (1°F)

**Heating cycle length:** 15 minutes

**Data protection:** In the event of a power failure, most settings are saved. However the time and Daylight Saving Time must be set if the power failure lasts more than 6 hours. The thermostat will return to the mode that was active prior to the power failure.